

## Montage-Kurzanleitung

### Gefahr



- Diese Montage-Kurzanleitung ersetzt nicht die ausführliche Betriebsanleitung, die vom Hersteller angefordert werden kann.
- Nur qualifiziertes Personal darf den Hubtrieb vor Wartungs- oder Instandsetzungsarbeiten gemäß DIN VDE freischalten.

### I. Montage

- Antrieb mit Traverse (2) auf Ventilhals (19) setzen
- Bügel (28) einschieben, Ventilschindel (18) mit Montagehilfe (23) nach oben ziehen bis Ventilschindel (18) in Kupplung (6) einrastet
- Traverse (2) mit Schrauben (428) Schlüsselweite 13 und Sicherungsscheiben (311) auf Ventilhals (19) befestigen

### II. Einbaulage

### III. Wechsel zwischen **A** Automatik- und **B** Handbetrieb

### IV. Schaltplan

### V. Steckbrückenübersicht

JP1	<input type="checkbox"/>	Eingangssignal Y = 0 ... 10 VDC od. 0 ... 20 mA
	<input type="checkbox"/>	Eingangssignal Y = 2 ... 10 VDC od. 4 ... 20 mA
JP2	<input type="checkbox"/>	Endposition = Antriebspindel ausgefahren
	<input type="checkbox"/>	Endposition = Antriebspindel eingefahren
JP3	<input type="checkbox"/>	Stellzeit 9 s/mm
	<input type="checkbox"/>	Stellzeit 5 s/mm
JP4	<input type="checkbox"/>	Hub Normaler Betrieb
	<input type="checkbox"/>	Hub Invertierter Betrieb
JP5	<input type="checkbox"/>	Jumper muss immer gesteckt sein damit der Betrieb gewährleistet ist.
JP6	<input type="checkbox"/>	Eingangssignal Y (mA)
	<input type="checkbox"/>	Eingangssignal Y (VDC)

### Technische Daten

Typ	MC55/24, MC55Y	MC55/230
<b>Versorgungsspannung</b>	24 V AC ± 10% 24 V DC ± 10%	115 V AC ± 10% 230 V AC + 6% -10%
	nur mit gleichgerichteter Wechselspannung	
<b>Frequenz</b>	50/60 Hz ± 5%	50/60 Hz ± 5%
<b>Umgebungstemperatur</b>	0 bis +60°C	
<b>Betriebsart</b>	S3 - 50 % ED	
<b>Schutzklasse</b>	IP 54 im Automatikbetrieb IP 30 bei Handbetätigung	

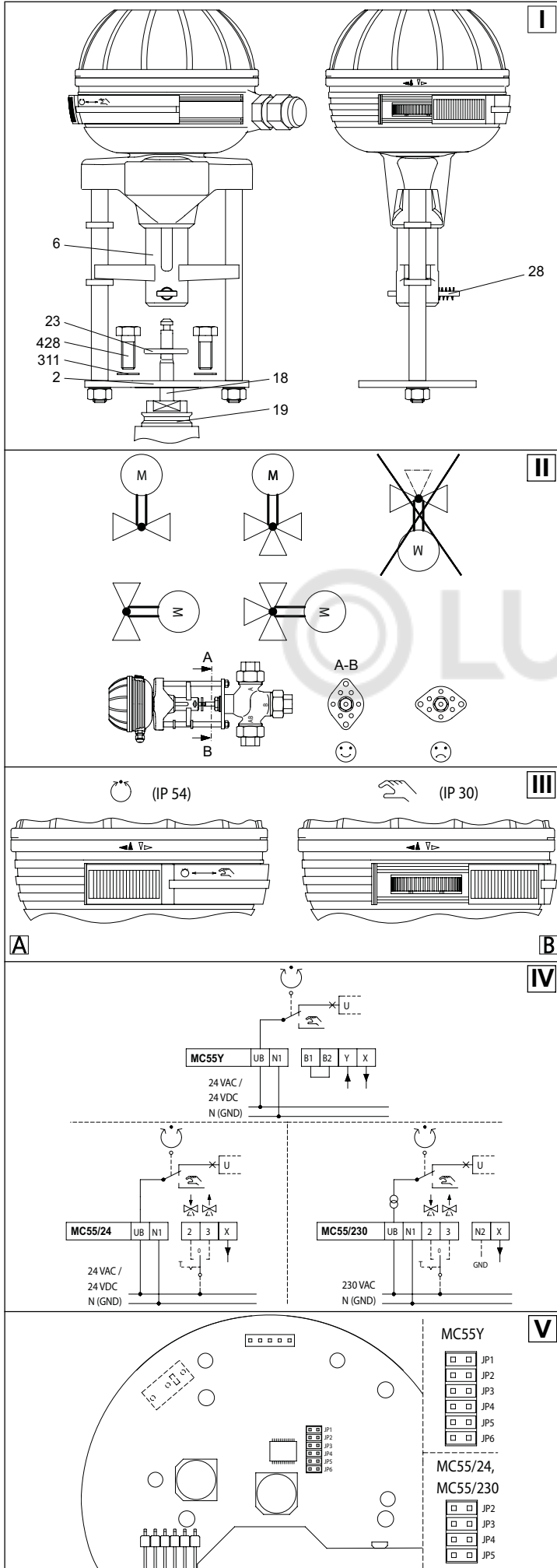

EN: Linear actuators MC55/24 • MC55/230 • MC55Y

FR: Entraînements de course verticale MC55/24 • MC55/230 • MC55Y

NL: Hefaanrijvingen MC55/24 • MC55/230 • MC55Y

## Short installation instructions

	<ul style="list-style-type: none"> <li>These short installation instructions shall not substitute the detailed operating instructions which can be obtained from the manufacturer.</li> <li>Qualified personnel only are allowed to isolate the linear actuator prior to maintenance and repair work according to DIN VDE.</li> </ul>
--	---

### I. Installation











- Place actuator with cross beam (2) onto valve neck (19)
- Insert mounting bracket (28), pull valve stem (18) upwards by means of mounting aid (23) until valve stem (18) engages into clutch (6)
- Fasten cross beam (2) by means of two screws (428) with A/F 13 and lock washers (311) at valve neck (19)

### II. Installation location

### III. Change over between automatic and manual mode

### IV. Circuit diagram

### V. Overview of plug-in jumpers

JP1		Input signal Y = 0 ... 10 VDC or 0 ... 20 mA
		Input signal Y = 2 ... 10 VDC or 4 ... 20 mA
JP2		Limit position = actuator spindle moved out
		Limit position = actuator spindle moved in
JP3		Setting time 9 s/mm
		Setting time 5 s/mm
JP4		Stroke Normal operation Input and output signal (Y,X)
		Stroke Inverted operation Input and output signal (Y,X)
JP5		Jumper must always be plugged to ensure operation.
JP6		Input signal Y (mA)
		Input signal Y (VDC)

### Technical Data

Type	MC55/24, MC55Y	MC55/230
Supply voltage	24 V AC ± 10% 24 V DC ± 10% at rectified a.c. voltage only	115 V AC ± 10% 230 V AC + 6% -10%
Frequency	50/60 Hz ± 5%	50/60 Hz ± 5%
Ambient temperature	0 to +60°C	
Operating mode	S3 - 50 % ED	
Protection class	IP 54 in automatic mode IP 30 in manual mode	

## Précis de montage

	<ul style="list-style-type: none"> <li>Ce précis de montage ne remplace pas la notice d'utilisation détaillée qui peut être commandée chez le fabricant.</li> <li>Seul un personnel qualifié est habilité à connecter l'entraînement de course verticale selon les directives de DIN VDE avant les travaux de maintenance ou de remise en état.</li> </ul>
---	--

### I. Montage











- Poser l'entraînement avec la traverse (2) sur le collet de valve (19)
- Insérer l'arceau (28), tirer l'arbre fileté conique de la valve (18) à l'aide du gabarit de montage (23) vers le haut jusqu'à ce que l'arbre fileté conique de la valve (18) s'enclenche dans l'accouplement (6)
- Fixer la traverse (2) par les vis (428) ouverture de clé 13 et les bagues de sûreté (311) sur le collet de valve (19)

### II. Position de montage

### III. Transition entre régime automatique et régime manuel

### IV. Schéma de connexions

### V. Vue d'ensemble des cavaliers

JP1		Signal d'entrée Y = 0 ... 10 VCC ou 0 ... 20 mA
		Signal d'entrée Y = 2 ... 10 VCC ou 4 ... 20 mA
JP2		Position de fin de course = bielle de commande déployée
		Position de fin de course = bielle de commande rentrée
JP3		Temps d'ajustage 9 s/mm
		Temps d'ajustage 5 s/mm
JP4		Course Régime normal Signal d'entrée et de sortie (Y,X)
		Course Régime inversé Signal d'entrée et de sortie (Y,X)
JP5		Le cavalier doit toujours être enfiché pour assurer le fonctionnement.
JP6		Signal d'entrée Y (mA)
		Signal d'entrée Y (mA)

### Caractéristiques techniques

Type	MC55/24, MC55Y	MC55/230
Tension d'alimentation	24 V CA ± 10% 24 V CC ± 10%	115 V CA ± 10% 230 V CA + 6% -10%
Fréquence	50/60 Hz ± 5%	50/60 Hz ± 5%
Température ambiante	de 0 à +60°C	
Mode opér.	S3 - 50 % ED	
Classe de protection	IP 54 en régime automatique IP 30 en régime manuel	

## Beknopte montagehandleiding

	<ul style="list-style-type: none"> <li>Deze beknopte montagehandleiding vervangt niet de uitvoerige gebruiksaanwijzing, die door de fabrikant opgevraagd kan worden.</li> <li>Enkel gekwalificeerd personeel mag de hefaanrijving vóór onderhoudswerkzaamheden of reparatiewerken conform DIN VDE vrij schakelen.</li> </ul>
---	--

### I. Montage











- Aandrijving met dwarsbalk (2) op ventielhals (19) zetten,
- Beugel (28) inschuiven, klepstang (18) met montagehulpmiddel (23) naar boven trekken totdat de klepstang (18) in koppeling (6) vast klikt.
- Dwarsbalk (2) met schroeven (428) sleutelwijdte 13 en borgplaatjes (311) op ventielhals (19) bevestigen.

### II. Inbouwpositie

### III. Wissel tussen automatische en handmatige modus

### IV. Stroomkringschema



















### V. Overzicht van de geleiderbruggen

JP1		Ingangssignaal Y = 0 ... 10 VDC of 0 ... 20 mA
		Ingangssignaal Y = 2 ... 10 VDC of 4 ... 20 mA
JP2		Eindstand = aandrijfspil uitgeklaapt
		Eindstand = aandrijfspil ingeschoven
JP3		Insteltijd 9 s/mm.
		Insteltijd 5 s/mm.
JP4		Slag Normale werking In- en uitgangssignaal (Y, X)
		Slag Omgekeerde werking In- en uitgangssignaal (Y, X)
JP5		Geleiderbrug moet altijd ingestoken zijn, opdat de werking gewaarborgd is.
JP6		Ingangssignaal Y (mA)
		Ingangssignaal Y (VDC)



















### Technische gegevens

Type	MC55/24, MC55Y	MC55/230
Voedingsspanning	24 V AC ± 10% 24 V DC ± 10% uitsluitend met gelijkgerichte wisselspanning.	115 V AC ± 10% 230 V AC + 6% -10%
Frequentie	50/60 Hz ± 5%	50/60 Hz ± 5%
Omgevingstemperatuur	0 tot +60°C	
Modus	S3 - 50 % ED	
Beschermingsniveau	IP 54 in de automatische modus IP 30 bij handmatige bediening	



















Istruzioni di montaggio abbreviati

Pericolo						
	<ul style="list-style-type: none"> <li>Queste istruzioni di montaggio abbreviati non sostituiscono le istruzioni di montaggio dettagliate, che possono essere richieste dal fabbricante.</li> <li>Solo personale qualificato può scollegare l'azionamento corsa secondo la DIN VDE prima di lavori di manutenzione o di riparazione.</li> </ul>					
I. Montaggio						
<ul style="list-style-type: none"> <li>Applicare l'azionamento con la traversa (2) sul collo della valvola (19)</li> <li>Inserire l'archetto (28), tirare in alto lo stelo della valvola (18) tramite l'aiuto di montaggio (23) finché lo stelo di valvola (18) innesti nell'accoppiamento (6)</li> <li>Fissare la traversa (2) tramite le viti (428) apertura di chiave 13 e dischi di sicurezza (311) sul collo di valvola (19)</li> </ul>						
II. Posizione di montaggio						
III. Cambio tra azionamento <input type="checkbox"/> automatico e <input checked="" type="checkbox"/> manuale						
IV. Schema elettrico						
V. Complessivo dei ponti ad innesto						
JP1		Segnale di ingresso Segnale di ingresso Y = 0 ... 10 VDC o 0 ... 20 mA				
		Segnale di ingresso Segnale di ingresso Y = 2 ... 10 VDC o 4 ... 20 mA				
JP2		Posizione finale = stelo di azionamento estratto				
		Posizione finale = stelo di azionamento ritirato				
JP3		Tempo di impostazione 9 s/mm				
		Tempo di impostazione 5 s/mm				
JP4		<table border="0"> <tr> <td>↑ Corso</td> <td>Funzionamento ordinario</td> </tr> <tr> <td></td> <td>Segnale di ingresso e di uscita (Y,X)</td> </tr> </table>	↑ Corso	Funzionamento ordinario		Segnale di ingresso e di uscita (Y,X)
↑ Corso	Funzionamento ordinario					
	Segnale di ingresso e di uscita (Y,X)					
		<table border="0"> <tr> <td>↑ Corso</td> <td>Esercizio inverso</td> </tr> <tr> <td></td> <td>Segnale di ingresso e di uscita (Y,X)</td> </tr> </table>	↑ Corso	Esercizio inverso		Segnale di ingresso e di uscita (Y,X)
↑ Corso	Esercizio inverso					
	Segnale di ingresso e di uscita (Y,X)					
JP5		Il jumper deve sempre essere innestato per poter garantire l'esercizio.				
JP6		Segnale di ingresso Y (mA)				
		Segnale di ingresso Y (VDC)				
Dati tecnici						
Tipo	MC55/24, MC55Y	MC55/230				
Tensione di alimentazione	24 V AC ± 10% 24 V DC ± 10%	115 V CA ± 10% 230 V AC + 6% -10%				
Frequenza	50/60 Hz ± 5%	50/60 Hz ± 5%				
Temp. ambiente	0 fino a +60°C					
Regime eserciz	S3 - 50 % ED					
Grado di protezione	IP 54 in esercizio automatico IP 30 con azionamento manuale					

Instrucciones abreviadas de montaje













Peligro						
	<ul style="list-style-type: none"> <li>Estas instrucciones abreviadas de montaje no reemplazan las instrucciones de servicio detalladas, que se pueden pedir al fabricante.</li> <li>Sólo personal cualificado puede desconectar el propulsor de elevación antes de trabajos de mantenimiento o de reparación según DIN VDE.</li> </ul>					
I. Montaje						
<ul style="list-style-type: none"> <li>Poner propulsor con traviesa (2) en el cuello de válvula (19)</li> <li>Enfilar el estribo (28), jalar arriba el husillo de válvula (18) con la ayuda de montaje (23) hasta que el husillo de válvula (18) enclique en el acoplamiento (6)</li> <li>Montar la traviesa (2) con los tornillos (428) ancho de llave 13 y las arandelas de seguridad (311) en el cuello de válvula (19)</li> </ul>						
II. Posición de montaje						
III. Cambio entre funcionamiento <input type="checkbox"/> automático y <input checked="" type="checkbox"/> manual						
IV. Esquema de conexiones						
V. Vista de conjunto de los puentes enchufables						
JP1		Señal de entrada Y = 0 ... 10 VDC ó 0 ... 20 mA				
		Señal de entrada Y = 2 ... 10 VDC ó 4 ... 20 mA				
JP2		Posición final = husillo de accionamiento salido				
		Posición final = husillo de accionamiento retirado				
JP3		Tiempo de ajuste 9 s/mm				
		Tiempo de ajuste 5 s/mm				
JP4		<table border="0"> <tr> <td>↑ Carrera</td> <td>Funcionamiento normal</td> </tr> <tr> <td></td> <td>Señal de entrada y de salida (Y,X)</td> </tr> </table>	↑ Carrera	Funcionamiento normal		Señal de entrada y de salida (Y,X)
↑ Carrera	Funcionamiento normal					
	Señal de entrada y de salida (Y,X)					
		<table border="0"> <tr> <td>↑ Carrera</td> <td>Funcionamiento invertido</td> </tr> <tr> <td></td> <td>Señal de entrada y de salida (Y,X)</td> </tr> </table>	↑ Carrera	Funcionamiento invertido		Señal de entrada y de salida (Y,X)
↑ Carrera	Funcionamiento invertido					
	Señal de entrada y de salida (Y,X)					
JP5		El puenteo tiene siempre que estar enchufado para poder garantizar el funcionamiento.				
JP6		Señal de entrada Y (mA)				
		Señal de entrada Y (VDC)				
Datos técnicos						
Tipo	MC55/24, MC55Y	MC55/230				
Tensión de alimentación	24 V AC ± 10% 24 V DC ± 10%	115 V AC ± 10% 230 V AC + 6% -10%				
Frecuencia	50/60 Hz ± 5%					
Temperatura ambiental	0 hasta +60°C					
Modo operat.	S3 - 50 % ED					
Clase de protección	IP 54 en funcionamiento automático IP 30 con accionamiento manual					

Instruções resumidas de montagem













Perigo						
	<ul style="list-style-type: none"> <li>Estas instruções resumidas de montagem não substituem as instruções de serviço pormenorizadas que se podem pedir ao fabricante.</li> <li>Só pessoal qualificado pode desligar o propulsor de curso antes de trabalhos de manutenção ou de revisão segundo DIN VDE.</li> </ul>					
I. Montagem						
<ul style="list-style-type: none"> <li>Colocar actuador com travessa (2) no colo da válvula (19)</li> <li>Introduzir o arco (28), puxar para cima o fuso de válvula (18) mediante a ajuda de montagem (23) até o fuso de válvula (18) engatar no acoplamento (6)</li> <li>Montar a travessa (2) com os parafusos (428) abertura de chave 13 e as arruelas de segurança (311) sobre o colo da válvula (19)</li> </ul>						
II. Posição de montagem						
III. Troca entre funcionamento <input type="checkbox"/> automático e <input checked="" type="checkbox"/> manual						
IV. Esquema das conexões						
V. Vista de conjunto das pontes encaixáveis						
JP1		Sinal de entrada Y = 0 ... 10 VDC ou 0 ... 20 mA				
		Sinal de entrada Y = 2 ... 10 VDC ou 4 ... 20 mA				
JP2		Posição final = fuso actuador fora				
		Posição final = fuso actuador dentro				
JP3		Tempo de regulagem 9 s/mm				
		Tempo de regulagem 5 s/mm				
JP4		<table border="0"> <tr> <td>↑ Curso</td> <td>Funcionamento normal</td> </tr> <tr> <td></td> <td>Sinal de entrada e de saída (Y,X)</td> </tr> </table>	↑ Curso	Funcionamento normal		Sinal de entrada e de saída (Y,X)
↑ Curso	Funcionamento normal					
	Sinal de entrada e de saída (Y,X)					
		<table border="0"> <tr> <td>↑ Curso</td> <td>Funcionamento invertido</td> </tr> <tr> <td></td> <td>Sinal de entrada e de saída (Y,X)</td> </tr> </table>	↑ Curso	Funcionamento invertido		Sinal de entrada e de saída (Y,X)
↑ Curso	Funcionamento invertido					
	Sinal de entrada e de saída (Y,X)					
JP5		A pontagem tem que estar sempre encaixada para poder garantir o funcionamento.				
JP6		Sinal de entrada Y (mA)				
		Sinal de entrada Y (VDC)				
Dados técnicos						
Tipo	MC55/24, MC55Y	MC55/230				
Tensão de abastecimento	24 V AC ± 10% 24 V DC ± 10%	115 V AC ± 10% 230 V AC + 6% -10%				
Frequência	50/60 Hz ± 5%					
Temp. ambiente	0 até +60°C					
Modo de funcionamento	S3 - 50 % ED					
Classe de protecção	IP 54 em funcionamento automático IP 30 em actuação manual					

**FI: Nostokkäytöt MC55/24 • MC55/230 • MC55Y**  
**SV: Slagdrivningar MC55/24 • MC55/230 • MC55Y**  
**PL: Siłowniki zaworowe MC55/24 • MC55/230 • MC55Y**













**Asennuksen lyhytohje**

<b>Vaara</b>		
	<ul style="list-style-type: none"> <li>Tämä asennusohje ei korvaa yksityiskohtaista käyttöohjetta, jonka voi saada valmistajalta.</li> <li>Vain pätevyyden omaava henkilökunta saa kytkeä nostokäytön DIN VDE mukaisesti ennen huolto- tai kunnossapitotöiden aloittamista.</li> </ul>	
<b>I. Asennus</b>		
<ul style="list-style-type: none"> <li>Aseta käyttö traversilla (2) venttiilinkaulaan (19)</li> <li>Työnnä kaari (28) sisään, vedä venttiilinkaraa (18) asennusavulla (23) ylös niin paljon, että venttiilinkara (18) napsahtaa kyttimeen (6)</li> <li>Kiinnitä traverssi (2) ruuveilla (428) jakoavaimella 13 ja lukkorenkaila (311) venttiilinkaulaan (19)</li> </ul>		
<b>II. Asennusasento</b>		
<b>III. Vaihto <input type="checkbox"/> automatiikasta <input type="checkbox"/> käsikäyttöön</b>		
<b>IV. KytKentäkaavio</b>		
<b>V. KytKentäsillan yleiskuva</b>		
JP1		Tulosignaali Y = 0 ... 10 VDC tai 0 ... 20 mA
		Tulosignaali Y = 2 ... 10 VDC tai 4 ... 20 mA
JP2		Pääteasento = Käyttökara ajettu ulos
		Pääteasento = Käyttökara ajettu sisään
JP3		Asetusaika 9 s/mm
		Asetusaika 5 s/mm
JP4		Iskun pituus Normaali käyttö Tulo- ja lähtösignaali X (Y,X) Y (Y,X)
		Iskun pituus Käänteiskäyttö Tulo- ja lähtösignaali X (Y,X) Y (Y,X)
JP5		Jumperin täytyy käytön varmistamiseksi olla pistettynä paikalleen.
JP6		Tulosignaali Y (mA)
		Tulosignaali Y (VDC)
<b>Tekniset tiedot</b>		
<b>Tyyppi</b>	<b>MC55/24, MC55Y</b>	<b>MC55/230</b>
<b>Syöttöjännite</b>	24 V AC ± 10% 24 V DC ± 10% vain tasasuunnatulla vaihtojännitteellä	115 V AC ± 10% 230 V AC + 6% -10%
<b>Taajuus</b>	50/60 Hz ± 5%	50/60 Hz ± 5%
<b>Ympäristön lämpötila</b>	0 - +60°C	
<b>Käyttötapa</b>	S3 - 50 % ED	
<b>Suojaluokka</b>	IP 54 automatiikkakäytössä IP 30 käsikäytössä	

**Förkortad montageanvisning**













<b>Fara</b>		
	<ul style="list-style-type: none"> <li>Den förkortade montageanvisningen ersätter inte den kompletta bruksanvisningen som kan beställas av leverantören.</li> <li>Endast kvalificerad personal får frikoppla liftmotorn för underhålls- eller reparationsarbeten enligt DIN VDE.</li> </ul>	
<b>I. Montering</b>		
<ul style="list-style-type: none"> <li>Sätt motorn med traversen (2) på ventilhalsen (19) skjut in bygeln (28)</li> <li>dra ventilskruven (18) uppåt med montagehjälpen (23) tills ventilskruven (18) fastnar i kopplingen (6).</li> <li>Fäst traversen (2) med skruvar (428) nyckelvidd 13 och säkringsbrickor(311) på ventilhalsen (19).</li> </ul>		
<b>II. Monteringsposition</b>		
<b>III. Byte mellan <input type="checkbox"/> automatik- och <input type="checkbox"/> manuell drift</b>		
<b>IV. Kopplingschema</b>		
<b>V. Stickbryggsöversikt</b>		
JP1		Ingångssignal Y = 0 ... 10 VDC el. 0 ... 20 mA
		Ingångssignal Y = 2 ... 10 VDC el. 4 ... 20 mA
JP2		Ändläge = drivningssskriv utkörd
		Ändläge = drivningssskriv indragen
JP3		Ställtid 9 s/mm
		Ställtid 5 s/mm
JP4		Slag Normal drift In- och utgångssignal X (Y,X) Y (Y,X)
		Slag Inverterad drift In- och utgångssignal X (Y,X) Y (Y,X)
JP5		Jumpern skall alltid vara satt för att garantera driften.
JP6		Ingångssignal Y (mA)
		Ingångssignal Y (VDC)
<b>Tekniska data</b>		
<b>Typ</b>	<b>MC55/24, MC55Y</b>	<b>MC55/230</b>
<b>Försörjnings spänning</b>	24 V AC ± 10% 24 V DC ± 10% Endast med likriktad växelspanning	115 V AC ± 10% 230 V AC + 6% -10%
<b>Frekvens</b>	50/60 Hz ± 5%	50/60 Hz ± 5%
<b>Omgivningst emperatur</b>	0 till +60°C	
<b>Driftsätt</b>	S3 - 50 % ED	
<b>Skyddsklass</b>	IP 54 i automatikdrift IP 30 vid manuell drift	

**Skrócona instrukcja montažu**













<b>Niebezpieczeństwo</b>		
	<ul style="list-style-type: none"> <li>Niniejsza skrócona instrukcja montažu nie zastępuje szczegółowej instrukcji eksploatacji, której można zażądać od producenta.</li> <li>Wyłącznie kwalifikowany personel może przed wykonaniem prac konserwacyjnych i naprawczych zgodnie z DIN VDE odłączyć napęd podnośny.</li> </ul>	
<b>I. Montaż</b>		
<ul style="list-style-type: none"> <li>Nasadzić napęd z trawersą (2) na szyjkę zaworu (19)</li> <li>Wsunąć pałąk (28), wrzeczono zaworu (18) pociągnąć do góry korzystając z pomocy montażowej (23) tak, aż wrzeczono zaworu (18) wżębi się w sprzęgło (6)</li> <li>Zamocować trawersę (2) śrubami (428) rozwarłość klucza 13 oraz zamocować tarcze zabezpieczające (311) na szyjce zaworu (19)</li> </ul>		
<b>II. Pozycja montažu</b>		
<b>III. Przejsćie z automatycznego <input type="checkbox"/> trybu pracy <input type="checkbox"/> na tryb ręczny i odwrotnie</b>		
<b>IV. Układ połączeń</b>		
<b>V. Przegląd mostków wtykowych</b>		
JP1		Sygnal wejściowy Y = 0 ... 10 VDC albo 0 ... 20 mA
		Sygnal wejściowy Y = 2 ... 10 VDC albo 4 ... 20 mA
JP2		Pozycja krańcowa = Wyjazd wrzeczona napędowego
		Pozycja krańcowa = Wjazd wrzeczona napędowego
JP3		Czas ustawiania 9 s/mm
		Czas ustawiania 5 s/mm
JP4		Skok Normalny tryb pracy Sygnal wejściowy i wyjściowy (Y,X)
		Skok Inwertowany tryb pracy Sygnal wejściowy i wyjściowy (Y,X)
JP5		Zworka musi być stale włożona, ponieważ zapewnia to działanie urządzenia.
JP6		Sygnal wejściowy Y (mA)
		Sygnal wejściowy Y (VDC)
<b>Dane techniczne</b>		
<b>Typ</b>	<b>MC55/24, MC55Y</b>	<b>MC55/230</b>
<b>Napięcie zasilania</b>	24 V AC ± 10% 24 V DC ± 10% Wyłącznie z wyprostowanym napięciem przemiennym	115 V AC ± 10% 230 V AC + 6% -10%
<b>Częstotliwość</b>	50/60 Hz ± 5%	50/60 Hz ± 5%
<b>Temp. otoczenia</b>	0 do +60°C	
<b>Tryb pracy</b>	S3 - 50 % ED	
<b>Klasa ochrony</b>	IP 54 w automatycznym trybie pracy IP 30 przy uruchomieniu ręcznym	

**LT: Kėlimo pavaros MC55/24 • MC55/230 • MC55Y**  
**LV: Lineārie spēka pievadi MC55/24 • MC55/230 • MC55Y**  
**ET: Tõstemehhanismi ajamid MC55/24 • MC55/230 • MC55Y**













**Trumpa montavimo instrukcija**

<b>Pavojus</b>		
	<ul style="list-style-type: none"> <li>• Si trumpa montavimo instrukcija nepakeičia išsamios gamintojo naudojimo instrukcijos.</li> <li>• Kėlimo pavaros techninės priežiūros ir remonto darbus gali vykdyti tik kvalifikuoti darbuotojai vadovaudamiesi DIN VDE standartais.</li> </ul>	
<b>I. Montavimas</b>		
<ul style="list-style-type: none"> <li>• Pavarą su sija (2) uždėkite ant vožtuvo kaklelio (19)</li> <li>• Įstumkite spaustuvą (28), vožtuvo kotą (18) su pagalbine montavimo priemone (23) į viršų traukite tol, kol vožtuvo kotas (18) užsifiksuos movoje (6)</li> <li>• Siją (2) 13 dydžio varžtas (428) 13 ir atraminėmis veržlėmis (311) pritvirtinkite prie vožtuvo kaklelio (19)</li> </ul>		
<b>II. Montavimo padėtis</b>		
<b>III. <input type="checkbox"/> Automatinio ir <input type="checkbox"/> rankinio režimo perjungimas</b>		
<b>IV. Jungimo schema</b>		
<b>V. Kištukinių tilielių apžvalga</b>		
<b>JP1</b>		Įvado signalas Y = 0 ... 10 VDC arba 0 ... 20 mA
		Įvado signalas Y = 2 ... 10 VDC arba 4 ... 20 mA
<b>JP2</b>		Galinė padėtis = pavaros kotas išstumtas
		Galinė padėtis = pavaros kotas įtrauktas
<b>JP3</b>		Nustatytas laikas 9 s/mm
		Nustatytas laikas 5 s/mm
<b>JP4</b>		Kėlimas Įprastinis režimas Įvado ir išvado signalas Y (Y,X)
		Kėlimas Invertinis režimas Įvado ir išvado signalas Y (Y,X)
<b>JP5</b>		Įrenginys veikia tik, kai jungė uždėta.
<b>JP6</b>		Įvado signalas Y (mA)
		Įvado signalas Y (VDC)
<b>Techniniai duomenys</b>		
<b>Tipas</b>	<b>MC55/24, MC55Y</b>	<b>MC55/230</b>
<b>Maitinimo įtampa</b>	24 V AC ± 10% 24 V DC ± 10%	115 V AC ± 10% 230 V AC + 6% -10%
	tik su tos pačios krypties kintamąja įtampa	
<b>Dažnis</b>	50/60 Hz ± 5%	50/60 Hz ± 5%
<b>Aplinkos temperatūra</b>	nuo 0 iki +60°C	
<b>Darbinis rež.</b>	S3 - 50 % ED	
<b>Saugiklio klasė</b>	IP 54 automatinio režimo IP 30 rankinio režimo	

**Saīsinātā montāžas instrukcija**















<b>Bīstami</b>		
	<ul style="list-style-type: none"> <li>• Šī saīsinātā montāžas instrukcija neaizvieto detalizētu lietošanas instrukciju, kuru varat pieprasīt no ražotāja.</li> <li>• Tikai kvalificēts personāls drīkst atvienot lineārā spēka pievadu no strāvas padeves pirms apkopes vai remontdarbu veikšanas atbilstoši standartam DIN VDE.</li> </ul>	
<b>I. Montāža</b>		
<ul style="list-style-type: none"> <li>• Spēka pievadu ar šķērssiju (2) uzlieciet uz vārsta kakla (19)</li> <li>• Iebīdīet skavu (28), vārsta kātu (18) ar montāžas piederumiem (23) pavelciet uz augšu, līdz vārsta kāts (18) nofiksējas savienotājuzmavā (6)</li> <li>• Šķērssiju (2) nostipriniet ar skrūvēm (428), uzgriežņu atslēgas atvere Nr. 13, un sprostaplāksnēm (311) nostipriniet uz vārsta kakla (19)</li> </ul>		
<b>II. Montāžas pozīcija</b>		
<b>III. Izvēle starp <input type="checkbox"/> automātisko un <input type="checkbox"/> manuālo režīmu</b>		
<b>IV. Slēgumu shēma</b>		
<b>V. Kontaktu tiltu pārskats</b>		
<b>JP1</b>		Saņemtais signāls Y = 0 ... 10 VDC vai 0 ... 20 mA
		Saņemtais signāls Y = 2 ... 10 VDC vai 4 ... 20 mA
<b>JP2</b>		Gala pozīcija = piedziņas vārpsta izvērziņa
		Gala pozīcija = piedziņas vārpsta ievērziņa
<b>JP3</b>		Nustatytas laikas 9 s/mm
		Nustatytas laikas 5 s/mm
<b>JP4</b>		Gājiens Parasts režīms Saņemtais un nosūtītais signāls (Y,X)
		Gājiens Invertēta darbība Saņemtais un nosūtītais signāls (Y,X)
<b>JP5</b>		Lai nodrošinātu darbību, „Jumper” ierīcei vienmēr jābūt pievienotai.
<b>JP6</b>		Saņemtais signāls Y (mA)
		Saņemtais signāls Y (VDC)
<b>Tehniskie dati</b>		
<b>Tipas</b>	<b>MC55/24, MC55Y</b>	<b>MC55/230</b>
<b>Barošanas spriegums</b>	24 V AC ± 10% 24 V DC ± 10%	115 V AC ± 10% 230 V AC + 6% -10%
	tikai ar iztaisnotu maiņstrāvu	
<b>Frekvence</b>	50/60 Hz ± 5%	50/60 Hz ± 5%
<b>Apkārtējās vides temp.</b>	0 līdz +60°C	
<b>Darba režīms</b>	S3 - 50 % ED	
<b>Aizsardzības klase</b>	IP 54 automātiskajā režīmā IP 30 pie manuālas iedarbināšanas	

**Lūhike monteerimisjuhīs**















<b>Oht</b>		
	<ul style="list-style-type: none"> <li>• See lūhijuhīs ei asenda ūksikasjalikku kasutusjuhendit, mida saate soovi korral kūside tootjalt.</li> <li>• DIN VDE kohaselt vōib tōstemehhanismi ajamid hooldustōōdeks vōi remondiks ette valmistada ainult kvalifitseeritud personal.</li> </ul>	
<b>I. Paigaldus</b>		
<ul style="list-style-type: none"> <li>• Paigutage ajam traaversiga (2) ventiili pūksile (19)</li> <li>• Lūkake sisse kammits (28) ja tōmmake ventiili spindlit (18) paigalduse abivahendiga (23) ūlespoole kuni ventiili spindel (18) fikseerub ūhendusseadmes (6) nōutavasse asendisse</li> <li>• Kinnitage ventiili pūksile (19) traavers (2) kruvide (428) ja kaitseseibidega (311) vōtmege nr. 13</li> </ul>		
<b>II. Paigaldusasend</b>		
<b>III. <input type="checkbox"/> Automaat- ja <input type="checkbox"/> manuaalrežiimi vahetus</b>		
<b>IV. Lūlītusplaan</b>		
<b>V. Ūlevaade elektrīhēndustest</b>		
<b>JP1</b>		Sisēndsignaal Y = 0 ... 10 VDC od. 0 ... 20 mA
		Sisēndsignaal Y = 2 ... 10 VDC vōi 4 ... 20 mA
<b>JP2</b>		Lōppasēnd = ajami spindel vāļjas
		Lōppasēnd = ajami spindel sees
<b>JP3</b>		Aēg 9 s/mm
		Aēg 5 s/mm
<b>JP4</b>		Kolvitōste Tavarežiim Sisēnd- ja vāļjundsignaal (Y,X)
		Kolvitōste Invertorrežiim Sisēnd- ja vāļjundsignaal (Y,X)
<b>JP5</b>		Tōōrežiimi tagamiseks peab jumper olema pidevalt ūhendatud.
<b>JP6</b>		Sisēndsignaal Y (mA)
		Sisēndsignaal Y (VDC)
<b>Tehnilisēd andmed</b>		
<b>Tūūp</b>	<b>MC55/24, MC55Y</b>	<b>MC55/230</b>
<b>Toitepinge</b>	24 V AC ± 10% 24 V DC ± 10%	115 V AC ± 10% 230 V AC + 6% -10%
	ainult stabilisēeritūd vahēlduvvoolu pingēga	
<b>Sagedus</b>	50/60 Hz ± 5%	50/60 Hz ± 5%
<b>Ūmbritsev temperatūur</b>	0 kuni +60°C	
<b>Tōōrežiim</b>	S3 - 50 % ED	
<b>Kaitseklase</b>	IP 54 automaatrežiimil IP 30 manuaalrežiimil	

**RU: Ходовые приводы MC55/24 • MC55/230 • MC55Y**  
**CS: Pohony zdvihu MC55/24 • MC55/230 • MC55Y**  
**SK: Zdvížené pohony MC55/24 • MC55/230 • MC55Y**















**Краткая инструкция по монтажу**

<b>Опасность</b>														
	<ul style="list-style-type: none"> <li>Данная краткая инструкция по монтажу не заменяет подробную инструкцию по эксплуатации, которую можно затребовать у изготовителя.</li> <li>Только квалифицированному персоналу разрешается производить отключение подъемного привода перед работами по техническому обслуживанию или ремонту согласно DIN VDE.</li> </ul>													
<b>I. Монтаж</b>														
<ul style="list-style-type: none"> <li>Привод с traversой (2) установить на горловину клапана (19)</li> <li>Вдвинуть скобу (28), стержень клапана (18) с помощью принадлежности для монтажа (23) потянуть вверх, пока стержень клапана (18) не защелкнется в муфте (6)</li> <li>Траверсу (2) с помощью болтов (428, ключ на 13) и стопорных шайб (311) закрепить на горловине клапана (19)</li> </ul>														
<b>II. Монтажное положение</b>														
<b>III. Переключение между  автоматическим и  ручным режимом</b>														
<b>IV. Блок-схема</b>														
<b>V. Обзор вставных перемычек</b>														
<b>JP1</b>		Входной сигнал Y = 0 ... 10 В пост. или 0 ... 20 mA												
		Входной сигнал Y = 2 ... 10 В пост. или 4 ... 20 mA												
<b>JP2</b>		Конечное положение = Шпindelь привода выдвинут												
		Конечное положение = Шпindelь привода задвинут												
<b>JP3</b>		Время перемещения 9 с/мм												
		Время позиционирования 5 с/мм												
<b>JP4</b>		<table border="0"> <tr> <td>Ход</td> <td>↑</td> <td>↓</td> <td>Х</td> <td>Y</td> <td>Нормальный режим работы</td> </tr> <tr> <td></td> <td></td> <td></td> <td></td> <td></td> <td>Входной и выходной сигнал (Y,X)</td> </tr> </table>	Ход	↑	↓	Х	Y	Нормальный режим работы						Входной и выходной сигнал (Y,X)
Ход	↑	↓	Х	Y	Нормальный режим работы									
					Входной и выходной сигнал (Y,X)									
		<table border="0"> <tr> <td>Ход</td> <td>↑</td> <td>↓</td> <td>Х</td> <td>Y</td> <td>Инвертированный режим</td> </tr> <tr> <td></td> <td></td> <td></td> <td></td> <td></td> <td>Входной и выходной сигнал (Y,X)</td> </tr> </table>	Ход	↑	↓	Х	Y	Инвертированный режим						Входной и выходной сигнал (Y,X)
Ход	↑	↓	Х	Y	Инвертированный режим									
					Входной и выходной сигнал (Y,X)									
<b>JP5</b>		Перемычка всегда должна быть вставлена, чтобы обеспечить работу.												
<b>JP6</b>		Входной сигнал Y (mA)												
		Входной сигнал Y (VDC)												
<b>Технические данные</b>														
<b>Тип</b>	<b>MC55/24, MC55Y</b>	<b>MC55/230</b>												
<b>Обеспечение напряжения</b>	24 В пер. ± 10% 24 В пост. ± 10%	115 В пер. ± 10% 230 В пер. +6%-10%												
<b>Частота</b>	50/60 Гц ± 5%	50/60 Гц ± 5%												
<b>Окруж. темп.</b>	от 0 до +60°C													
<b>Режим работы</b>	S3 - 50 % ED													
<b>Класс защиты</b>	IP 54 в автоматическом режиме IP 30 при ручном управлении													

**Stručný úvod do montáže**

<b>Nebezpečí</b>						
	<ul style="list-style-type: none"> <li>Tento stručný úvod do montáže nenahrazuje důkladný návod k použití, který může výrobce požadovat.</li> <li>Pohon zdvihu smí před údržbou a opravami v souladu s normou DIN VDE spustit pouze kvalifikovaný personál.</li> </ul>					
<b>I. Montáž</b>						
<ul style="list-style-type: none"> <li>Pohon s traversou (2) nasadit na krček ventilu (19)</li> <li>Zasunout třmínek (28), vřeteno ventilu (18) pomocí montážního přípravku (23) vytáhnout nahoru, dokud vřeteno ventilu (18) nezaklapne do spojky (6)</li> <li>Traverzu (2) pojistit šrouby (428) velikost 13 a pojistnými podložkami (311) na krček ventilu (19)</li> </ul>						
<b>II. Montážní poloha</b>						
<b>III. Přechod mezi  automatickým a  ručním provozem</b>						
<b>IV. Schéma zapojení</b>						
<b>V. Přehled násuvného můstku</b>						
<b>JP1</b>		Vstupní signál Y = 0 ... 10 V stejnosměr.proudu nebo 0 ... 20 mA				
		Vstupní signál Y = 2 ... 10 V stejnosměr.proudu nebo 4 ... 20 mA				
<b>JP2</b>		Koncová poloha = Vyjeto hnací vřeteno				
		Koncová poloha = Najeto hnací vřeteno				
<b>JP3</b>		Nastavený čas 9 s/mm				
		Nastavený čas 5 s/mm				
<b>JP4</b>		<table border="0"> <tr> <td>↑ Zdvih</td> <td>Normální provoz</td> </tr> <tr> <td></td> <td>Vstupní a výstupní signál (Y,X)</td> </tr> </table>	↑ Zdvih	Normální provoz		Vstupní a výstupní signál (Y,X)
↑ Zdvih	Normální provoz					
	Vstupní a výstupní signál (Y,X)					
		<table border="0"> <tr> <td>↑ Zdvih</td> <td>Inverzní provoz</td> </tr> <tr> <td></td> <td>Vstupní a výstupní signál (Y,X)</td> </tr> </table>	↑ Zdvih	Inverzní provoz		Vstupní a výstupní signál (Y,X)
↑ Zdvih	Inverzní provoz					
	Vstupní a výstupní signál (Y,X)					
<b>JP5</b>		Spojka musí být vždy zasunutá aby se umožnil provoz.				
<b>JP6</b>		Vstupní signál Y (mA)				
		Vstupní signál Y (VDC)				
<b>Technické údaje</b>						
<b>Typ</b>	<b>MC55/24, MC55Y</b>	<b>MC55/230</b>				
<b>Napájení</b>	24 V střídavý proud ± 10 % 24 V jednosměrný proud ± 10 %	115 V střídavý proud ± 10% 230 V střídavý proud ± 10% + 6% -10%				
<b>Frekvence</b>	50/60 Hz ± 5 %	50/60 Hz ± 5 %				
<b>Okolní teplot</b>	0 až +60 °C					
<b>Provoz.režim</b>	S3 - 50 % ED					
<b>Třída ochrany</b>	IP 54 při automatickém provozu IP 30 při ručním ovládní					

**Stručný úvod do montáže**













<b>Nebezpečie</b>						
	<ul style="list-style-type: none"> <li>Tento stručný úvod do montáže nenahrádza dôkladný návod na použitie, ktorý môže výrobca požadovať.</li> <li>Pohon zdvihu pred údržbou a opravami smie v súlade s normou DIN VDE spustiť výhradne kvalifikovaný personál.</li> </ul>					
<b>I. Montáž</b>						
<ul style="list-style-type: none"> <li>Nasadiť pohon s traversou (19) na krčku ventilu (19)</li> <li>Nasunúť strmienok (28), vřeteno ventilu (18) pomocou montážneho prípravku (23) vytiahnuť hore, kým vřeteno ventilu (18) nezaklapne do spojky (6)</li> <li>Traverzu (2) upevniť skrutkami (428) veľkosti 13 a poistnými podložkami (311) na krček ventilu (19)</li> </ul>						
<b>II. Pozícia montáže</b>						
<b>III. Prechod od  automatickej prevádzky  k ručnej</b>						
<b>IV. Schéma zapojenia</b>						
<b>V. Přehľad nástřcného mostíka</b>						
<b>JP1</b>		Vstupný signál Y = 0 ... 10 V jednosmerného prúdu alebo 0 ... 20 mA				
		Vstupný signál Y = 2 ... 10 V jednosmerného prúdu alebo 4 ... 20 mA				
<b>JP2</b>		Koncová poloha = hnacie vřeteno vysunuté				
		Koncová poloha = hnacie vřeteno vsunuté				
<b>JP3</b>		Doba nastavenia 9 s/mm				
		Doba nastavenia 5 s/mm				
<b>JP4</b>		<table border="0"> <tr> <td>↑ Zdvih</td> <td>Normálna prevádzka</td> </tr> <tr> <td></td> <td>Vstupný a výstupný signál (Y,X)</td> </tr> </table>	↑ Zdvih	Normálna prevádzka		Vstupný a výstupný signál (Y,X)
↑ Zdvih	Normálna prevádzka					
	Vstupný a výstupný signál (Y,X)					
		<table border="0"> <tr> <td>↑ Zdvih</td> <td>Inverzná prevádzka</td> </tr> <tr> <td></td> <td>Vstupný a výstupný signál (Y,X)</td> </tr> </table>	↑ Zdvih	Inverzná prevádzka		Vstupný a výstupný signál (Y,X)
↑ Zdvih	Inverzná prevádzka					
	Vstupný a výstupný signál (Y,X)					
<b>JP5</b>		Spojka musí byť vždy nasadená, aby bola možná prevádzka.				
<b>JP6</b>		Vstupný signál Y (mA)				
		Vstupný signál Y (VDC)				
<b>Technické údaje</b>						
<b>Typ</b>	<b>MC55/24, MC55Y</b>	<b>MC55/230</b>				
<b>Zásobovacie napätie</b>	24 V AC ± 10% 24 V DC ± 10%	115 V ss ± 10% 230 V AC + 6% -10%				
<b>Frekvencia</b>	50/60 Hz ± 5 %	50/60 Hz ± 5 %				
<b>Teplota okolia</b>	0 až +60°C					
<b>Druh prevádzky</b>	S3 - 50 % ED					
<b>Trieda ochrany</b>	IP 54 pri automatickej prevádzke IP 30 pri ručnom ovládní					

SL: Dvižne pogonske enote MC55/24 • MC55/230 • MC55Y













SH: Podizni mehanizmi MC55/24 • MC55/230 • MC55Y

HR: Podizni mehanizmi MC55/24 • MC55/230 • MC55Y













### Kratko navodilo za montažo

<b>Nevarnost</b>		
	<ul style="list-style-type: none"> <li>To kratko navodilo za montažo ne nadomešča obširnih navodil za uporabo, ki jih lahko zahtevate od proizvajalca.</li> <li>Dvižno pogonsko enoto sme pred servisnimi in vzdrževalnimi deli v skladu z DIN VDE aktivirati le kvalificirano osebje.</li> </ul>	
<b>I. Montaža</b>		
<ul style="list-style-type: none"> <li>Pogonsko enoto s traverzo (2) položite na grlo ventila (19)</li> <li>Vstavite ročaj (28) Vreteno ventila (18) s pripomočkom za montažo (23) potegnite navzgor, dokler se vreteno ventila (18) ne zaskoči v sklopko (6)</li> <li>Traverzo (2) z vijaki (428) velikosti ključa 13 in varnostnimi podložkami (311) pritrđite na grlo ventila (19)</li> </ul>		
<b>II. Vgradni položaj</b>		
<b>III. Menjava med <input type="checkbox"/> avtomatičnim in <input type="checkbox"/> ročnim delovanjem</b>		
<b>IV. Stikalni načrt</b>		
<b>V. Pregled vtičnih mostičev</b>		
JP1		Vhodni signal Y = 0 ... 10 VDC ali 0 ... 20 mA
		Vhodni signal Y = 2 ... 10 VDC ali 4 ... 20 mA
JP2		Končni položaj = Pogonsko vreteno izvoženo
		Končni položaj = Pogonsko vreteno uvoženo
JP3		Čas delovanja 9 s/mm
		Čas delovanja 5 s/mm
JP4		Dvig Normalno delovanje Vhodni in izhodni signal X (Y,X) Y (Y,X)
		Dvig Invertirano delovanje Vhodni in izhodni signal X (Y,X) Y (Y,X)
JP5		Mostič mora biti vedno vtaknjen, da je delovanje zagotovljeno.
JP6		Vhodni signal Y (mA)
		Vhodni signal Y (VDC)
<b>Tehnični podatki</b>		
Tip	MC55/24, MC55Y	MC55/230
Napajanje z napetostjo	24 V AC ± 10% 24 V DC ± 10%	115 V AC ± 10% 230 V AC + 6% -10%
Frekvenca	50/60 Hz ± 5%	50/60 Hz ± 5%
Temp. okolja	0 do +60°C	
Obratovalni način	S3 - 50 % ED	
Zaščitni razred	IP 54 v avtomatičnem načinu delovanja IP 30 pri ročni aktivaciji	















### Kratko uputstvo za montažo

<b>Opasnost</b>		
	<ul style="list-style-type: none"> <li>Ovo kratko uputstvo za montažo nije zamena za iscrpno uputstvo za upotrebu koje može da zahteva proizvođač.</li> <li>Samo kvalifikovano osoblje sme da isključi podizni mehanizam s napajanja pre radova održavanja i popravaka u skladu sa propisima DIN VDE.</li> </ul>	
<b>I. Montaža</b>		
<ul style="list-style-type: none"> <li>Mehanizam sa traverzom (2) postavite na stablo ventila (19)</li> <li>Ugurajte sponu (28) pa povucite vreteno ventila (18) prema gore koristeći pomoćne elemente za montažu (23) dok se ono (18) ne uglati u spojnicu (6)</li> <li>Traverzu (2) zavrtnjima (428) spoljnog prečnika 13 i sigurnosnim prstenima (311) pričvrstite na stablo ventila (19)</li> </ul>		
<b>II. Položaj za ugradnju</b>		
<b>III. Mogućnosti <input type="checkbox"/> automatskog i <input type="checkbox"/> ručnog upravljanja</b>		
<b>IV. Šema vezivanja</b>		
<b>V. Pregled prenosnika</b>		
JP1		Ulazni signal Y = 0 ... 10 VDC ili 0 ... 20 mA
		Ulazni signal Y = 2 ... 10 VDC ili 4 ... 20 mA
JP2		Krajnji položaj = pogonsko vreteno izbačeno
		Krajnji položaj = pogonsko vreteno uvučeno
JP3		Vreme nameštanja 9 s/mm
		Vreme nameštanja 5 s/mm
JP4		Podizanje Normalan rad Ulazni i izlazni signal X (Y,X) Y (Y,X)
		Podizanje Invertirani rad Ulazni i izlazni signal X (Y,X) Y (Y,X)
JP5		Prenosnik mora uvek da bude utaknut kako bi se garantovao rad.
JP6		Ulazni signal Y (mA)
		Ulazni signal Y (VDC)
<b>Tehnični podaci</b>		
Tip	MC55/24, MC55Y	MC55/230
Napon napajanja	24 V AC ± 10% 24 V DC ± 10%	115 V AC ± 10% 230 V AC + 6% -10%
Frekvencija	50/60 Hz ± 5%	50/60 Hz ± 5%
Temp. okolin	0 do +60°C	
Način rada	S3 - 50 % ED	
Stepen zatite	IP 54 u automatskom načinu rada IP 30 pri ručnom pokretanju	

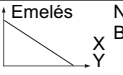
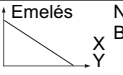
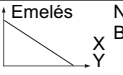

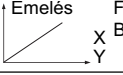
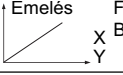
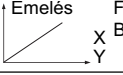











### Kratke upute za montažu

<b>Opasnost</b>		
	<ul style="list-style-type: none"> <li>Ove kratke upute za montažu nisu zamjena iscrpnim uputama za upotrebu koje može zahtijevati proizvođač.</li> <li>Samo kvalificirano osoblje smije isključiti podizni mehanizam s napajanja prije radova održavanja i popravaka u skladu s propisima DIN VDE.</li> </ul>	
<b>I. Montaža</b>		
<ul style="list-style-type: none"> <li>Mehanizam s traverzom (2) postavite na stablo ventila (19)</li> <li>Ugurajte sponu (28) pa povucite vreteno ventila (18) prema gore pomoću pomoćnih elemenata za montažu (23) dok se ono (18) ne uglati u spojku (6)</li> <li>Traverzu (2) vijcima (428) vanjskog promjera 13 i sigurnosnim prstenima (311) pričvrstite na stablo ventila (19)</li> </ul>		
<b>II. Položaj za ugradnju</b>		
<b>III. Mogućnosti <input type="checkbox"/> automatskog i <input type="checkbox"/> ručnog upravljanja</b>		
<b>IV. Spojna shema</b>		
<b>V. Pregled prijemnika</b>		
JP1		Ulazni signal Y = 0 ... 10 VDC ili 0 ... 20 mA
		Ulazni signal Y = 2 ... 10 VDC ili 4 ... 20 mA
JP2		Krajnji položaj = pogonsko vreteno izbačeno
		Krajnji položaj = pogonsko vreteno uvučeno
JP3		Vrijeme namještanja 9 s/mm
		Vrijeme namještanja 5 s/mm
JP4		Podizanje Normalan rad Ulazni i izlazni signal X (Y,X) Y (Y,X)
		Podizanje Invertirani rad Ulazni i izlazni signal X (Y,X) Y (Y,X)
JP5		Prijemnik mora uvijek biti utaknut kako bi se zajamilo rad.
JP6		Ulazni signal Y (mA)
		Ulazni signal Y (VDC)
<b>Tehnički podatki</b>		
Tip	MC55/24, MC55Y	MC55/230
Opskrbni napon	24 V AC ± 10% 24 V DC ± 10%	115 V AC ± 10% 230 V AC + 6% -10%
Frekvencija	50/60 Hz ± 5%	50/60 Hz ± 5%
Temp. okolin	0 do +60°C	
Način rada	S3 - 50 % ED	
Klasa zaštite	IP 54 u automatskom načinu rada IP 30 pri ručnom pokretanju	

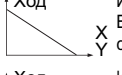
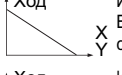
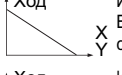

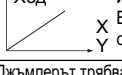
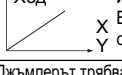
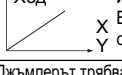











Szerelés rövid útmutatója

Vigyázat								
	<ul style="list-style-type: none"> <li>Ez a rövid szerelési útmutató nem helyettesíti a részletes használati utasítást, melyet kérni lehet a gyártótól.</li> <li>Csak szakképzett személyzetnek szabad az emelőhajtást karbantartási és javítási munkák előtt DIN VDE szerint szabaddá kapcsolni.</li> </ul>							
I. Szerelés								
<ul style="list-style-type: none"> <li>Hajtást tartógerendával (2) a szelepnakra (19) helyezni</li> <li>Kengyelt (28) bedugni, szeleposót (18) szerelősegítséggel (23) felfelé húzni, míg a szeleposó (18) bekattan a kuplungba (6)</li> <li>Tartógerendát (2) csavarokkal (428) kulcsnyílás 13 és biztosító alátétekkel (311) a szelepnakra (19) erősíteni</li> </ul>								
II. Beépítési helyzet								
III. Csere <input type="checkbox"/> automatikus és <input type="checkbox"/> kézi üzem között								
IV. Kapcsolóterv								
V. Kapcsolóhíd áttekintés								
JP1		Bejövő jel Y = 0 ... 10 VDC vagy 0 ... 20 mA						
		Bejövő jel Y = 2 ... 10 VDC vagy 4 ... 20 mA						
JP2		Végpozíció = hajtó orsó kitolva						
		Végpozíció = hajtó orsó behúzva						
JP3		Beállítási idő 9 s/mm						
		Beállítási idő 5 s/mm						
JP4		<table border="0"> <tr> <td></td> <td>Emelés</td> <td>Normmális üzem</td> </tr> <tr> <td></td> <td></td> <td>Be és kilépőjel (Y,X)</td> </tr> </table>		Emelés	Normmális üzem			Be és kilépőjel (Y,X)
	Emelés	Normmális üzem						
		Be és kilépőjel (Y,X)						
		<table border="0"> <tr> <td></td> <td>Emelés</td> <td>Fordított üzem</td> </tr> <tr> <td></td> <td></td> <td>Be és kilépőjel (Y,X)</td> </tr> </table>		Emelés	Fordított üzem			Be és kilépőjel (Y,X)
	Emelés	Fordított üzem						
		Be és kilépőjel (Y,X)						
JP5		Jumpernek mindig bedugva kell lenni, hogy az üzemelés biztosítva legyen.						
JP6		Belépőjel Y (mA)						
		Belépőjel Y (VDC)						
Műszaki adatok								
Típus	MC55/24, MC55Y	MC55/230						
Tápfeszültség	24 V AC ± 10% 24 V DC ± 10%	115 V AC ± 10% 230 V AC + 6% -10%						
Frekvencia	50/60 Hz ± 5%	50/60 Hz ± 5%						
Környezethőmérséklet	0-től +60°C-ig							
Üzemmód	S3 - 50 % ED							
Védőosztály	IP 54 automatikus üzemben IP 30 kézi működtetésnél							

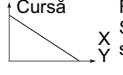
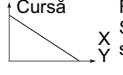
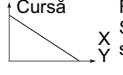
Кратка инструкция за монтаж

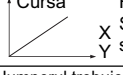
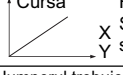
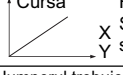
Опасност								
	<ul style="list-style-type: none"> <li>Тази кратка инструкция за монтаж не заменя подробната инструкция за обслужване, която може да бъде поискана от производителя.</li> <li>Само квалифициран персонал има правото да изключва ходовото задвижане преди дейности по поддръжката или текущите ремонти съгл. DIN VDE.</li> </ul>							
I. Монтаж								
<ul style="list-style-type: none"> <li>Поставете задвижването с траверсата (2) на шийката на клапана (19)</li> <li>Вкарайте скобата (28), издърпайте шпиндела на клапана (18) с помощта при монтаж (23) нагоре, докато шпинделът на клапана (18) се фиксира в съединителя (6).</li> <li>Закрепете траверсата (2) с винтове (428) с гаечен ключ с размер 13 и осигурителни шайби (311) на шийката на клапана (19)</li> </ul>								
II. Монтажни положения								
III. Смяна между <input type="checkbox"/> автоматичен и <input type="checkbox"/> ръчен режим на работа								
IV. Електрическа схема								
V. Преглед щекерни мостове								
JP1		Входящ сигнал Y = 0 ... 10 VDC или 0 ... 20 mA						
		Входящ сигнал Y = 2 ... 10 VDC или 4 ... 20 mA						
JP2		Крайно положение = задвижващ шпиндел изнесен						
		Крайно положение = задвижващ шпиндел вкаран						
JP3		Време за регулиране 9 сек/мм						
		Време за регулиране 5 сек/мм						
JP4		<table border="0"> <tr> <td></td> <td>Ход</td> <td>Инвертиран режим на раб.</td> </tr> <tr> <td></td> <td></td> <td>Входящ и изходящ сигнал (Y,X)</td> </tr> </table>		Ход	Инвертиран режим на раб.			Входящ и изходящ сигнал (Y,X)
	Ход	Инвертиран режим на раб.						
		Входящ и изходящ сигнал (Y,X)						
		<table border="0"> <tr> <td></td> <td>Ход</td> <td>Инвертиран режим на раб.</td> </tr> <tr> <td></td> <td></td> <td>Входящ и изходящ сигнал (Y,X)</td> </tr> </table>		Ход	Инвертиран режим на раб.			Входящ и изходящ сигнал (Y,X)
	Ход	Инвертиран режим на раб.						
		Входящ и изходящ сигнал (Y,X)						
JP5		Джъмперът трябва винаги да е поставен, за да се осъществи режимът на работа.						
JP6		Входящ сигнал Y (mA)						
		Входящ сигнал Y (VDC)						
Технически данни								
Тип	MC55/24, MC55Y	MC55/230						
Захранващо напрежение	24 V AC ± 10% 24 V DC ± 10%	115 V AC ± 10% 230 V AC + 6% -10%						
Честота	50/60 Hz ± 5%	50/60 Hz ± 5%						
Околна темп	0 до +60°C							
Вид на работене	S3 - 50 % ED							
Защитен клас	IP 54 в автоматичен режим на работа IP 30 при ръчно задействане							

Instrucțiuni de montaj succinte

Pericol								
	<ul style="list-style-type: none"> <li>Aceste instrucțiuni succinte de montaj nu înlocuiesc instrucțiunile de exploatare detaliate, care se pot solicita de la producător.</li> <li>Numai un personal calificat poate deconecta sistemul de acționare de ridicare, înainte de lucrările de întreținere sau de reparații, conform normelor DIN VDE.</li> </ul>							
I. Montajul								
<ul style="list-style-type: none"> <li>Sistemul de acționare cu traversa (2) se amplasează pe gâtul ventilului (19)</li> <li>Se împinge mânerul (28), cu ajutorul elementului de montaj (23) tija filetată a ventilului (18) se trage în sus, până când tija filetată a ventilului (18) se blochează în cuplajul (6)</li> <li>Traversa (2), cu șuruburile (428) cu deschidere cheie de 13 și șaibele de siguranță (311), se fixează pe gâtul ventilului (19)</li> </ul>								
II. Poziția de montaj								
III. Schimbare între <input type="checkbox"/> regim de lucru automat și <input type="checkbox"/> regim de lucru manual								
IV. Schemă								
V. Vedere de ansamblu punți cu fișă								
JP1		Semnal de intrare Y = 0 ... 10 VCC sau 0 ... 20 mA						
		Semnal de intrare Y = 2 ... 10 VCC sau 4 ... 20 mA						
JP2		Poziție finală = Ax de antrenare în poziție avansată						
		Poziție finală = Ax de antrenare în poziție retrasă						
JP3		Timp de reglare 9 s/mm						
		Timp de reglare 5 s/mm						
JP4		<table border="0"> <tr> <td></td> <td>↑ Cursă</td> <td>Funcționare normală</td> </tr> <tr> <td></td> <td></td> <td>Semnal de intrare și semnal de ieșire (Y,X)</td> </tr> </table>		↑ Cursă	Funcționare normală			Semnal de intrare și semnal de ieșire (Y,X)
	↑ Cursă	Funcționare normală						
		Semnal de intrare și semnal de ieșire (Y,X)						
		<table border="0"> <tr> <td></td> <td>↑ Cursă</td> <td>Funcționare inversă</td> </tr> <tr> <td></td> <td></td> <td>Semnal de intrare și semnal de ieșire (Y,X)</td> </tr> </table>		↑ Cursă	Funcționare inversă			Semnal de intrare și semnal de ieșire (Y,X)
	↑ Cursă	Funcționare inversă						
		Semnal de intrare și semnal de ieșire (Y,X)						
JP5		Jumperul trebuie să fie întotdeauna introdus, pentru a se asigura funcționarea						
JP6		Semnal de intrare Y (mA)						
		Semnal de intrare Y (VDC)						
Date tehnice								
Tip	MC55/24, MC55Y	MC55/230						
Tensiune de alimentare	24 V CA ± 10% 24 V CC ± 10%	115 V CA ± 10% 230 V CA + 6% -10%						
Frevență	50/60 Hz ± 5%	50/60 Hz ± 5%						
Temperatura mediului ambiant	0 până la +60°C							
Mod de lucru	S3 - 50 % ED							
Clasa de protecție	IP 54 în regim de lucru automat IP 30 în regim de lucru manual							